

1978-73 MAZDA RX4

FRONT BUMPER & LAMPS

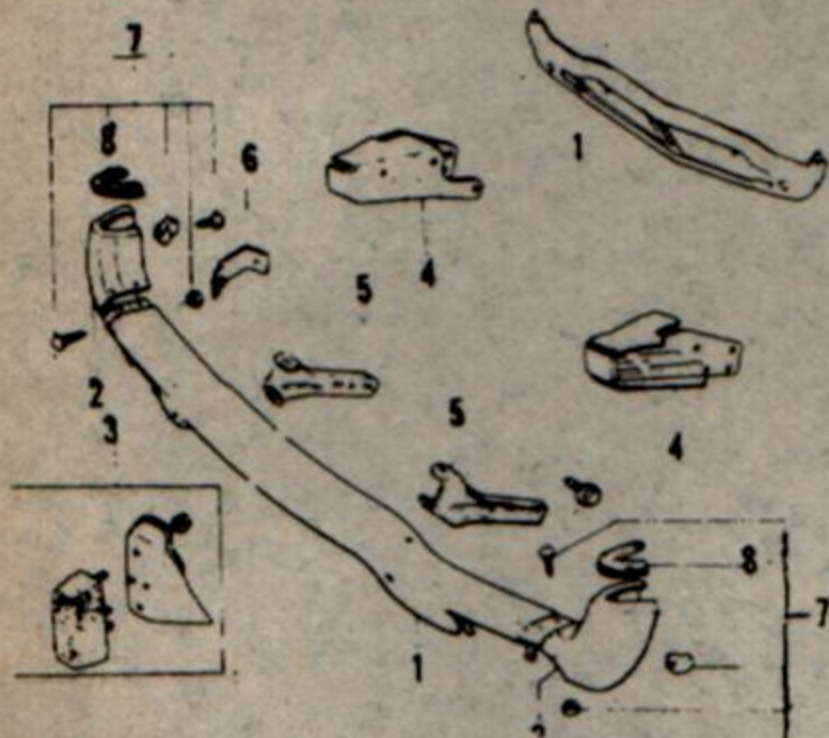

FRONT BUMPER, 1973-74 HARDTOP

Assy, R&I .6, Overhaul 1.0			
1	Face bar, center	60.50	.6 175750030
2	-side	33.70	#.6 101150040C-50C
3	Guard, w/cushion	69.70	.3 175799801C-2C
4	Mounting, brkt, R-L	11.60	175752710
5	stay	6.50	101150081A-91A
6	plate, end, R-L	1.15	101152970A
7	Cover & end fixing set	4.50	101199916
8	cover only (rubber)	1.15	101150012B
	Valance panel	(p.8) 46.45	§.4 175752910

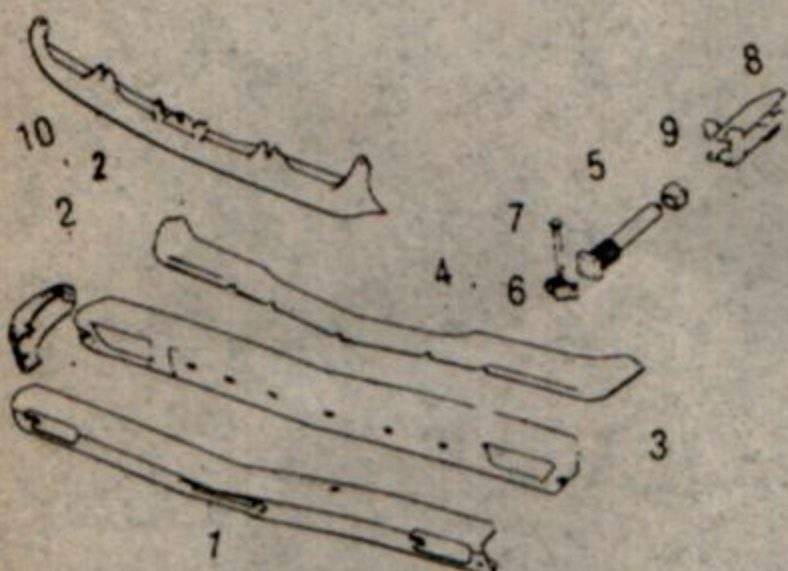

FRONT BUMPER, 1973-74 SEDAN & STA WGN

Assy, R&I .4, Overhaul 1.0			
1	Face bar, center	72.05	.5 175550180A
2	-side, exc	30.25	.2 175550050B-60B
	-Sed, from 6/74	18.50	2 175850050-600
	-SW, from 4/74	30.25	2 175550050B-60B
3	Reinforcement, exc	101.20	175550040B
	Sed, from 6/74	107.65	175650040
4	Filler to grille, exc	(p.5) 53.65	§.3 175550150B00
	Sed, from 4/74	63.90	§.3 356550190
5	Energy absorber, exc	22.45	§.2 175550100B
	-from 3/74	22.45	§.2 175550100B
	-Sed from 6/74	23.85	§.2 175650100A
6	hinge plate, to face bar	6.55	175550080A
7	-bolt	4.10	175550071A
8	bracket, exc	13.75	175550110A-30A
	Sedan, from 6/74	13.75	175550110A
9	rubber mtg, rear, exc	1.80	175550091
	Sed from 6/74	1.80	175650091
10	Valance panel	(p.1.0) 61.35	.4 175552910I

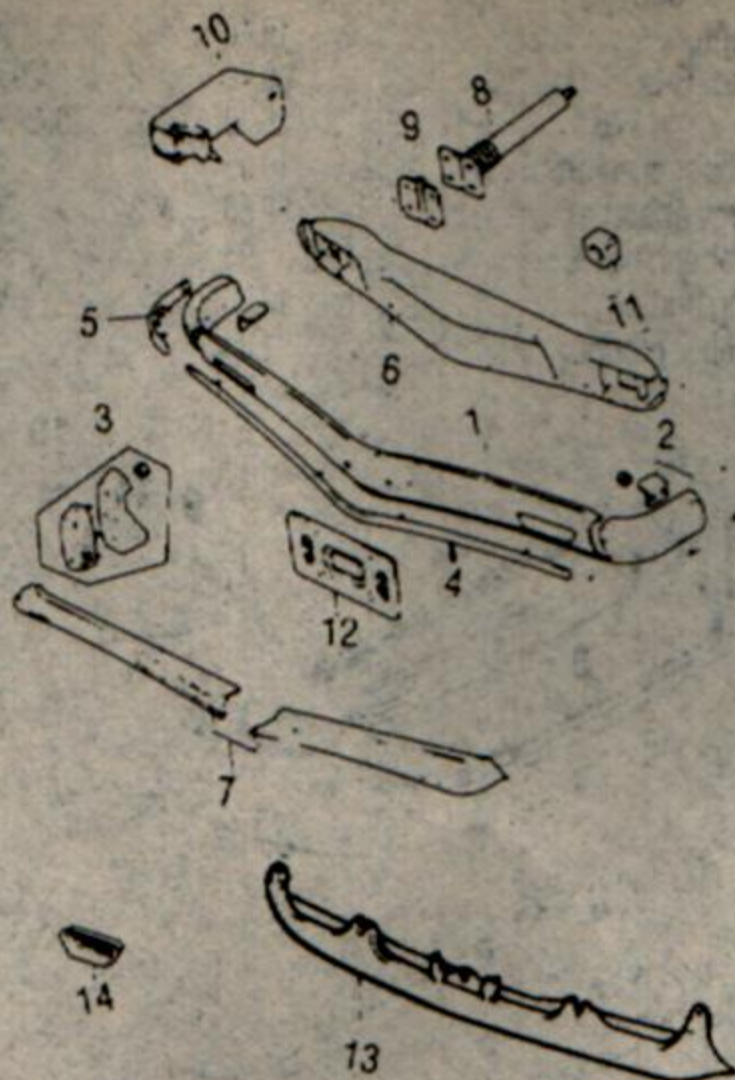

FRONT BUMPER, 1975

Assy, R&I .4, Overhaul 1.3			
1	Face bar, center	106.80	†1.3 356550031A
2	-side	29.10	356550910-200
3	Guard, w/cushion	59.40	.3 356799801A-2A
4	Rubber cush, center	10.10	.5 356550170E
5	-side, R-L	9.10	.5 356550180F
6	Reinforcement	83.65	356550040E
7	Filler, to grille	63.90	§.3 356550190
8	Energy absorber	62.40	§.2 356550100
9	hinge plate, to face bar	7.85	356550080A
10	bracket, rear	31.40	356550110A-30A
11	rubber mount, rear	1.80	175650091
12	License mtg plate	3.70	356550015
13	Valance panel	(p.8) 61.35	§.4 175552910I

FRONT BUMPER, 1976-78

Assy, R&I .6, Overhaul 1.1			
	Face bar, center	106.80	#1.1 364850031A
	-side	30.25	.3 362550032-30
	Guard w/cushion	59.40	.3 356799801A-2A
	Rubber cushion, side, R-L	9.10	356550180F
	Reinforcement	83.65	356550040E
	Filler to grille	(p.5) 22.10	§.3 364850151A
	Energy absorber	69.50	§.3 364850100A
	hinge plate, to face bar	7.85	356550080A
	bracket rear	31.40	356550110A-30A
	rubber mount rear	1.80	175650091
	License mtg plate	7.00	364850030
	Valance panel	(p.6) 46.45	.8 364852910

PARKING LAMP, SEDAN & STA WGN 1973-74,

	Assembly, wo/door	17.85	.3 175589662-70
14	Door	11.10	175550025
	Lens	2.40	.1 175551061-710
	gasket	1.35	175551063-730
	Bulb	.50	0000111157

PARKING LAMP, HARDTOP 1973-74

	Assembly	12.75	.3 175789662-70
	Lens	2.80	.1 086666112-420
	gasket	1.15	086666113-430
	Bulb	.50	0000111157

PARKING LAMP 1975-77

	Assembly	17.65	.3 356589662-70
	Lens	2.40	.1 175551061-710
	gasket	1.35	175551063-730
	Bulb	.50	0000111157

Time is for one or both.
§ After bumper is removed.
† Time is for overhaul.

FRAME

	Crossmember, front	7.55	# 2.0 101153162
	Hook, front, exc	6.30	086678541B
	-from 5/74	6.30	086678541B
	Sidemember— front, exc	67.00	†6.0 101153300I-4300I

-74	67.00	†6.0	101153300I-4300I
-75	67.00	†6.0	101153300I-4300I
-76-78	85.20	†6.0	364853300B-4300B

After bumper & other bolted-on parts are removed.
† After all bolted-on parts are removed. With wheelhouse removed 3.0.

GRILLE & HEADLAMPS

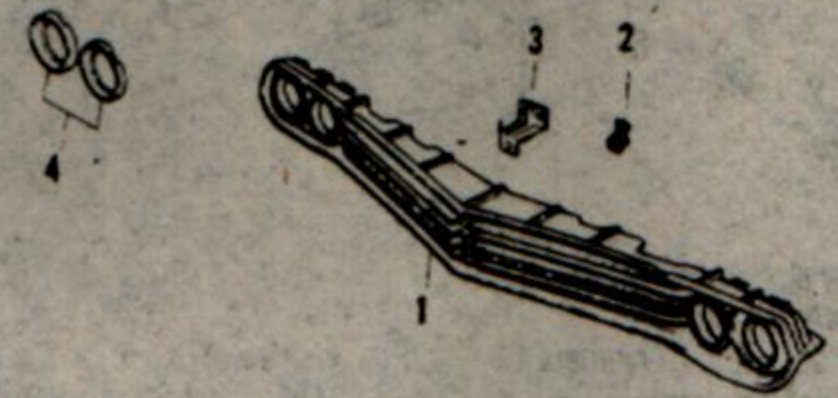

GRILLE, 1973-75

1	Grille	139.40	.5 101150711B04
	Emblem	21.00	101189601
	Name, Rotary Engine	3.25	188169076
	mtg plate	1.05	101151772A
	Support, see radiator		
2	Bracket, R-L, outer	.95	101152951
3	-inner	1.30	101152952
	-cntr, vertical	1.20	101150730

1976-78

	Grille	69.30	.5 364850711 08
	Moulding, surround	45.25	.3 870250770A08
	Name plate, Mazda	4.35	870251771A
	Mtg panel	(p.1.5) 164.05	2.8 364852810

HEADLAMP

	Aim headlamps		.5	
	Housing exc	16.30		101151041A
	-76-78	16.30		189366031A-61A
4	Door, exc	14.40	.1	101150721B
	-76-78	35.00	.1	364850740A01
	Seal beam (each)	3.26	.4	
	retaining ring	5.60		265166024
	mounting ring, outer	5.30		072787012-220
	-inner	5.30		072787013-230

COOLING

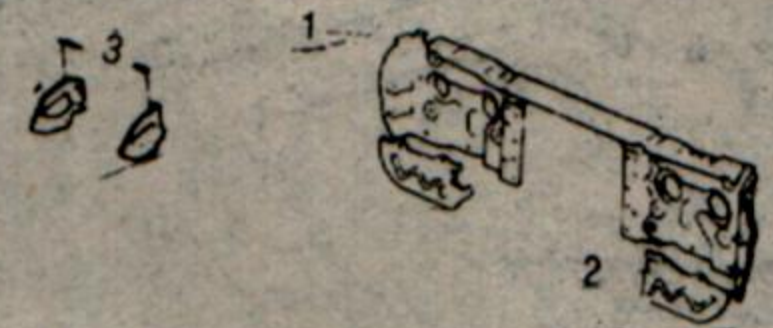

RADIATOR

	Rad, StdTrans, exc	197.60	#.7	175715310A
	-75-78	210.75	#.7	120215310B
	-AutoTrans, exc	243.65	#.8	175815310A
	-75-78	228.40	#.8	120815310B
	Reserve tank, exc	11.45	.1	105215350A
	-75	11.45	.1	105215350A
	-76-78	44.90	.1	356515350B
	Supt, grille, rad & h'lamp mtg—			
1	assy, exc	(p.1.0) 84.05	§.4.0	364853100D
	-from 5/74	(p.1.0) 84.05	§.4.0	364853100D
	-76-78	(p.1.0) 84.05	§.4.0	364853100D
	splash shield—			
2	outer, HT exc	(p.5) 9.40		852756131A-410
	-fm 11-74	(p.5) 6.30		175556131-410
	-76-78	(p.5) 6.30		364856131-410
	-all, 76-77	(p.5) 6.30		364856131
3	inner	1.55		101152941A-6A
	Oil cooler, exc	189.05	†.6	175714700D
	-75-78	189.05	†.6	356514700
	Hose, upper, exc	5.90	.3	170815511
	-75-78	5.35	.3	356515511A
	-lower, exc	4.90	.4	170815521
	-75-78	4.00	.4	356515521A

CONTINUED

COOLING (CONT)

FAN			
Blade, exc	23.20	±.3	109715200
-1975	20.10	±.3	390015200
-76-78	25.10	±.3	364815200A
Drive unit, w/fan, exc	96.50	±.3	190715250
-75	148.90	±.3	364815250A
-76-78	148.90	±.3	364815250A
-wo/fan, exc	76.15	±.3	190715210
-75	148.90	±.3	364815250A
-76-78	112.10	±.3	120215210
Pulley, exc	7.30		175715151A
-75-78	7.30	.4	175715151B
Shroud, upper, exc	9.90		176915411B
-75-78	12.70		356515411B
-lower, exc	8.70		176915421B
-75-78	12.00		356515421A
BELTS			
Alternator	4.25	.3	852718381
Compressor			
w/o PwrStrg	5.30	.3	175715906
w/PwrStrg & AC	3.10	.3	176915906
w/PwrStrg	2.95	.3	352315907
WATER PUMP			
Pump & thermostat assy			
assy, exc	20.85	>.9	175799153
-fm 3/74	20.85	>.9	175799153
-75	20.85	>.9	175799153
-76-78	47.60	>.8	126915010D
Pump only—			
assy, exc	20.85	>.4	175799153
-75	16.80	>.4	190799150C
-76-78	20.85	>.4	175799153

With air cond, add .1.

§ With bumper, grille, lamps and one fender removed. With both fenders removed 3.0.

† With air cond, add .4

‡ If item is made accessible by work being performed, adjust time accordingly.

> With AC add .1.

AIR CONDITIONER & HEATER

With any operation requiring a coolant line disconnect, add 1.0 to recharge system & add for freon.

AIR CONDITIONER

LESS POWER STEERING—

condenser	243.55	1.0	176961480
receiver & dehydrator	57.70	.3	101161500A
compressor	115.00	1.0	176961450R
mtg brkt	126.00		176915921C
clutch assy	203.60	1.6	088176370
-pulley & clutch	22.55	1.6	088176738
-coil	51.25		088176713
hose, cond to comp	43.40	1.0	176961461B
-comp to evap	43.40	1.0	176961461B
pipe, dehyd to evap	33.25		173461464A
dehyd-to cond	11.40		086661463
evaporator core	181.75		173476704
expansion valve	46.20		101176734

WITH POWER STEERING—

SEE LESS PWR STRG, EXC

compressor	115.00	1.0	176961450R
mtg brkt, exc	126.00		176915921C
-76-78	126.00		176915921C
pulley	70.46		176976881
clutch wheel	231.40	1.1	176976870
coil	59.45		176976871
hose, cond to comp exc	43.40	1.0	176961461B
-fm 12/73	43.40	1.0	176961461B
-76-78	43.40	1.0	176961461B
-comp to evap exc	56.35	1.0	176961462A
-fm 12/73	56.35	1.0	176961462A

HEATER

Motor, exc	64.25	#.5	170876424A
-76-78	97.40	1.4	359776424
Fan	11.50		170876421

With air cond, 1.4.

HOOD

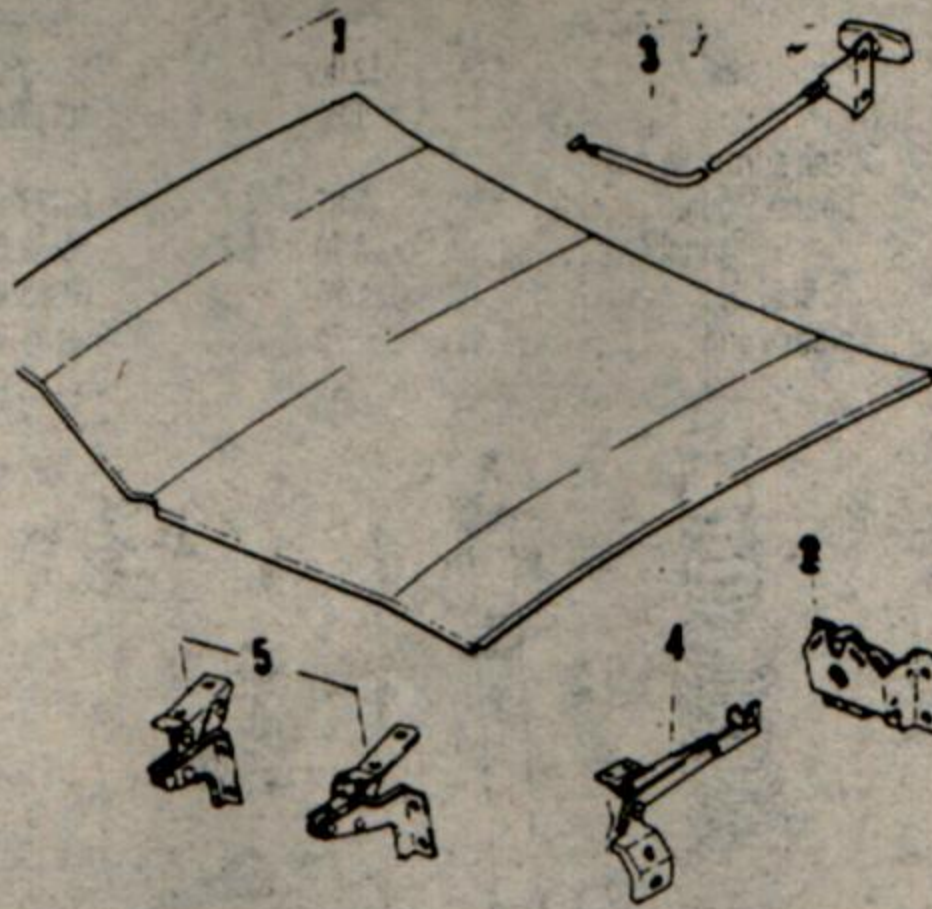

Assembly, Remove & Reinstall		.4	
1 Hood panel exc	(p2.0)	159.75	.8
-76-78	(p2.0)	159.75	.8
Insulator—			
1974-75—			
front		3.10	101168662
rear		6.45	101168661A
side left		2.40	101168663
-right		1.15	101168664
1976-78—			
front		1.80	807268662
rear		2.50	807268661
side		1.90	807268663
Moulding, front edge		21.60	.2
2 Lock, exc		12.25	.2
-76-78		12.25	.2
3 release cable		5.60	.3
4 Support (stay), exc		6.55	.1
-76-78		5.15	.1
5 Hinge, R-L, exc	(p.3)	9.40	#.2
-76-78	(p.3)	9.40	#.2
Counter balance spring		7.65	364852551A-61A

After hood is removed.

FRONT FENDER & LAMPS

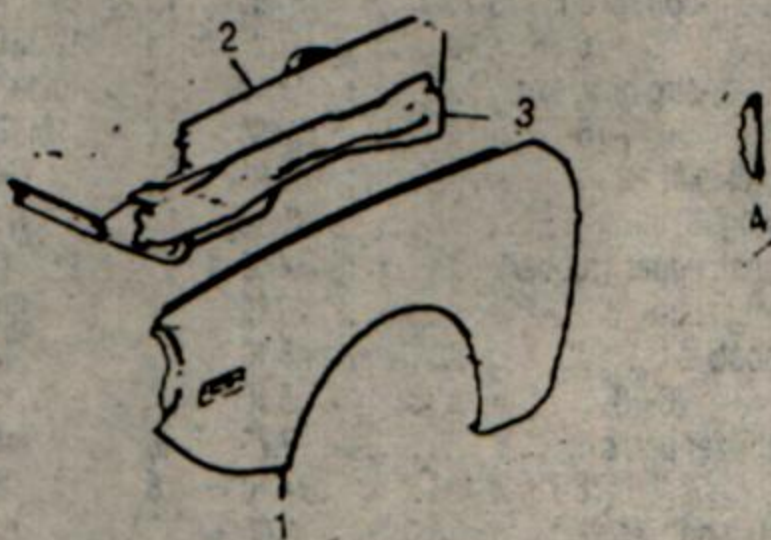

FRONT FENDER			
1 Fender exc	(p2.0)	147.95	2.0
-76-78	(p2.0)	147.95	2.0
Moulding, front		11.80	.1
Name, Mazda	(d.1)	9.85	.2
-RX4	(d.1)	8.50	.2
-Rotary	(d.1)	4.20	.2
2 Wheelhouse, exc	(p1.0)	126.50	#.7.5
-fm 11/73	(p1.0)	126.50	#.7.5
-fm, 1976	(p1.0)	126.50	#.7.5
3 reinforcement		17.50	101153281A-4281A
4 Splash shield, front, exc		3.10	101156261A-710A
-76-78		1.20	364856261-710

SIDE MARKER LAMP

Assembly		17.40	.2	175789663-80
Lens & housing		14.55	.1	175751121-310
Bulb		.65		0000110089

After fender, bumper and front suspension are removed.

ELECTRICAL

BATTERY

Battery, National	48.35		000080024K
-GS, N70Z	52.65		000080270
-GS, N50Z	48.35		000080024K
Carrier	9.90		101153260B
Cable, positive	12.70	.4	171267250
-negative	10.85	.4	100767260A

ALTERNATOR & REGULATOR

Alternator assy	105.00	.6	852718300FXC
pulley & fan	8.55	.4	175724530
Voltage regulator	32.40		045318391

DISTRIBUTOR & IGNITION

Dist assy, StdTrans	123.40	.5	175718200A
-AutoTrans	123.40	.5	175818200A
-1975 (all)	144.40	.5	356518200
-76-78 (all)	177.20	.5	364818200
cap	11.20	.3	175724310
rotor, exc	3.40		175724303
-76-78	3.40		364824303
Ignition coil, exc	28.05	.2	152418100A
-76-78	28.05	.2	167218100
switch & lock	55.70	.7	17575990A

LAMPS

Headlamps, see grille			
Parking lamps, see front bumper			
Sidemarkers lamps—			
front, see fender			
rear, see quarter			
Tail lamps—			
Sed & HT, see rear body			
Sta Wgn, Signal-see quarter			
-tail-see lift gate			
License lamps—			
Sed & HT, see rear bumper			
Sta Wgn, see lift gate			
Back-up lamps—			
Sed & HT, see rear body			

HORN

Horn, high tone	15.00		172066780C
-low tone	15.00		172066790C

ENGINE

ENGINE, R&I

All, exc		#.3.8	
-w/Auto Trans		#.4.3	

ENGINE, OVERHAUL

All, exc		#.12.7	
-w/Auto Trans		#.13.2	

ENGINE PARTS

Crankshaft pulley, exc	41.75	.8	175711600E
-76-78	41.75	.8	852811600
Front cover exc	20.35	#.3.5	352310600
-74-78	20.35	#.3.5	352310600
gasket	.80		175710641
Engine mounting—			
crossmbr, front, exc	20.60		102939060
-76-78	28.80		124339060
-rear, exc	7.40		102739380B
-76-78	10.30		124339381B
rubber mtg, front, r	8.70	.4	166839040D
-L	13.40	.4	117539040A
-brkt, exc	17.25		102939020
-76-78	17.25		102939020
-rear at trans	11.50	.4	101139340A
Oil pan, exc	20.70	.8	175710700B
-1975	34.10	.8	364823075
-76-78	34.10	.8	364823075
gasket exc	2.90		175710711
-76-78	1.79		
Oil cooler, exc	189.05	\$.6	175714700D
-fm 2/74	189.05	\$.6	175714700D
-75-78	189.05	\$.6	356514700
mtg insulator, each	5.45		175715312
hose, inlet	20.00		086514720
-outlet	31.30		157014730A
Fuel pump, exc	46.90	.4	175723650B
-fm 4/74	46.90	.4	179123650B

With air cond, add .6.

§ With air cond, add .4.

CONTINUED

1978-73 MAZDA RX4

CLUTCH & TRANSMISSION

CLUTCH (OR DISC) R&I OR RENEW

All models	2.6
TRANSMISSION	
Standard, R&I	2.5
-Overhaul, 4 speed	5.7
-5 speed	6.6
Automatic, R&I	3.0
-Overhaul	10.5

EXHAUST

Manifold (reactor), exc	297.95	1.0	175713800
-75 w/Std Trans	297.95	1.0	356513800A
-76-78	330.90	1.0	364813800B
gasket, side, 73-75	1.25		175713889B
-76-78	4.05		850113889D
-rear, 73-75	1.25		175713891
-76-78	1.80		887113891
hot air duct, 73-75	9.05		356513330A
-76-78	9.00		364813330B
cover plate, exc	17.69		356513380B
-76-78	19.90		364813380A
Pipes & mufflers, 73-75—			
pipe & muffler, front	121.00	.8	175740600F
muffler, rear—			
Sedan & H'Top, exc	160.80	.8	175740500C
-75 H'Top	146.20	.8	177340500
Sta Wgn, 73-74	160.80	.8	179140500D
-75	160.80	.8	357140500C
Diffuser plate	3.70	.3	356540090
cover, Sed & H'Top, exc	24.75		126140560
-75	6.60		125940551A
-Sta Wgn	5.30		357140560
Pipes & muffler, 76-78—			
Pipe, front	185.10		364840620G
Muffler, front	173.30	.8	871240320
-middle, exc	126.05	.8	125940200E
-Sta Wgn	126.05	.8	126140200D
rear w/diffuser, R exc	137.85	.5	125940500B
-Sta Wgn	137.85	.5	365040500
plate diffuser	3.70		356540090
cover, exc	24.75		126140560
-Sta Wgn	5.30		357140560
Air inlet pipe—			
pipe, front	11.75		364840720C
-flex	23.10		364840730
Air outlet pipe—			
pipe, front	42.70		364840430A
-inter	8.15		125940610

EXHAUST EMISSION SYSTEM

Air pump, w/pulley	246.15	.4	175713710
pulley	10.05	.3	175723713
adjusting brkt	1.90		175713714
belt	4.90		175713715
Air control valve—			
assy, w/sol, std, exc	110.30	.4	188113720
-75	139.70	.4	356513720A
-76-78	139.70	.4	364813720B
-auto, exc	110.30	.4	175813720
-75	139.70	.4	356513720A
solenoid, exc	23.20	.2	175723725
-75	16.60	.2	356523725
Valve, check, exc	9.70		175813730
-75	8.80		356513730
-76-78	8.80		850113730B
altitude comp, exc	22.25		175713770A
-75	22.25		175713770B
EC	61.90		175713910
deceleration control	33.50		175713750R

WHEELS & FRONT SUSPENSION

Wheel alignment, 1.5
Toe-in, adjust .5
Assy, OH 1 side 2.5, both 4.0

WHEELS

Wheel, 73-75	(p.5)	45.60	#.3	996507553 08
-76-78, exc	(p.5)	50.20	#.3	996513553008
-H'Top	(p.5)	45.60	#.3	996507553 08

Hub cap, exc	10.65		101137191B
-1975	14.90		101137191C
-76-78	34.75		368337170
adaptor, exc	3.80		175726570
-from 5/74	3.80		175726570
rubber seal	12.00		124333047
Trim ring	1.60		101137192
Bearing, front wheel—			
bearing, outer	9.85	\$.7	031733075
-inner	8.10	\$.7	854533047
oil seal	1.70		039833065
grease cap	.70		025933071

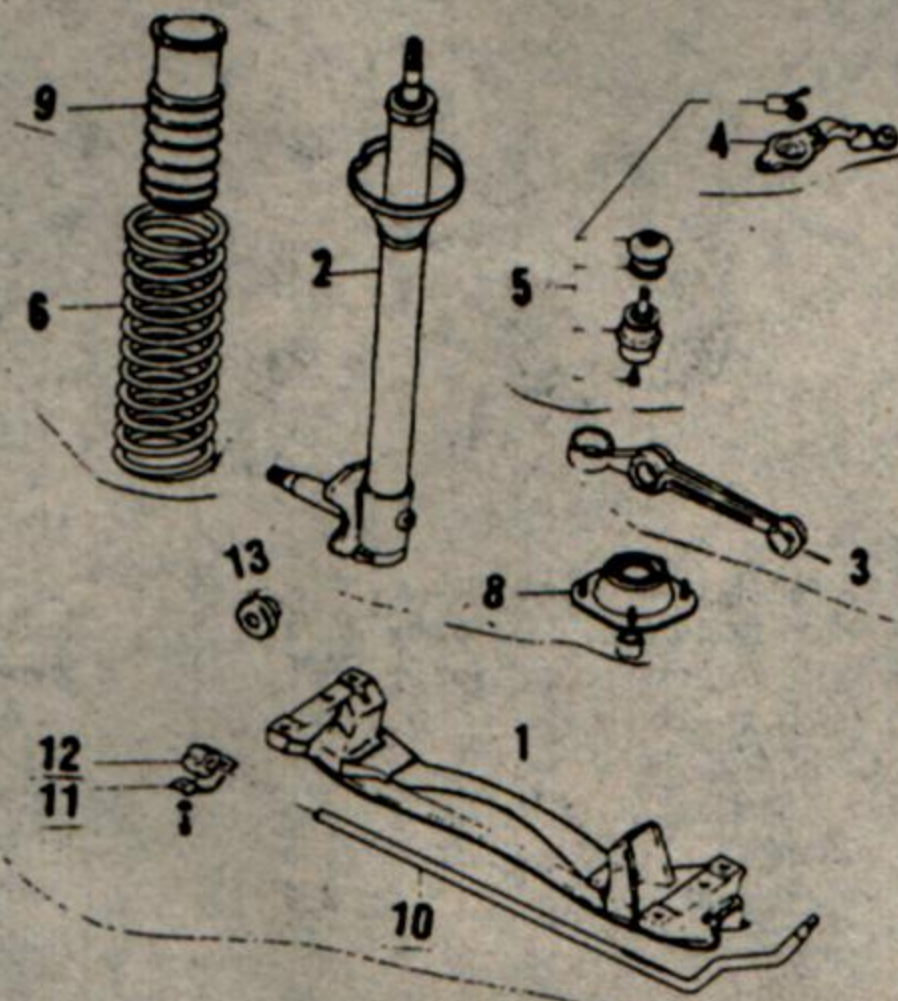

FRONT SUSPENSION

1 Crossmember, exc	128.65	3.0	101134800A
76-78	128.65	3.0	124334800A
Hub	30.25	.7	082033091B
Brake disc	29.90	.6	030533251B
caliper assy, exc	94.50	.6	897533980
-74-75	94.50	.6	897533980
-76-78	94.50	.6	364833980-4900
splash shield	12.25		101133260
hose	6.40	.6	175743810
Steering knuckle & shock—			
2 assembly, exc	112.75	1.3	175734910B
-fm 2/75	112.75	1.3	175734910B
-76-78	112.75	1.3	364834910
arm, strg & control	128.95		101134310D-320D
3 -control only, 73-75	51.50	1.1	101134311
-76-78	47.25	1.1	124334310A-60A
4 -strg only, exc	17.10	.6	101132301B-11B
-76-78	23.90	.6	124332301-110
5 ball-joint	18.95		086699356A
6 Spring	49.10	1.3	175734011A
7 seat, upper (rubber)	4.00		175734340
8 mtg plate	29.90		101134380B
9 boot, exc	5.10		124334015
-76-78	5.10		124334015
10 Stabilizer bar, exc	77.75	.6	101134151
-76-78	74.10	.6	364834151
11 supt brkt	1.05		025934155
12 bushing, inner	2.80		175734156
13 -outer	1.40		175734153

Add for balance, weights and valve stem.
§ One or both.

STEERING

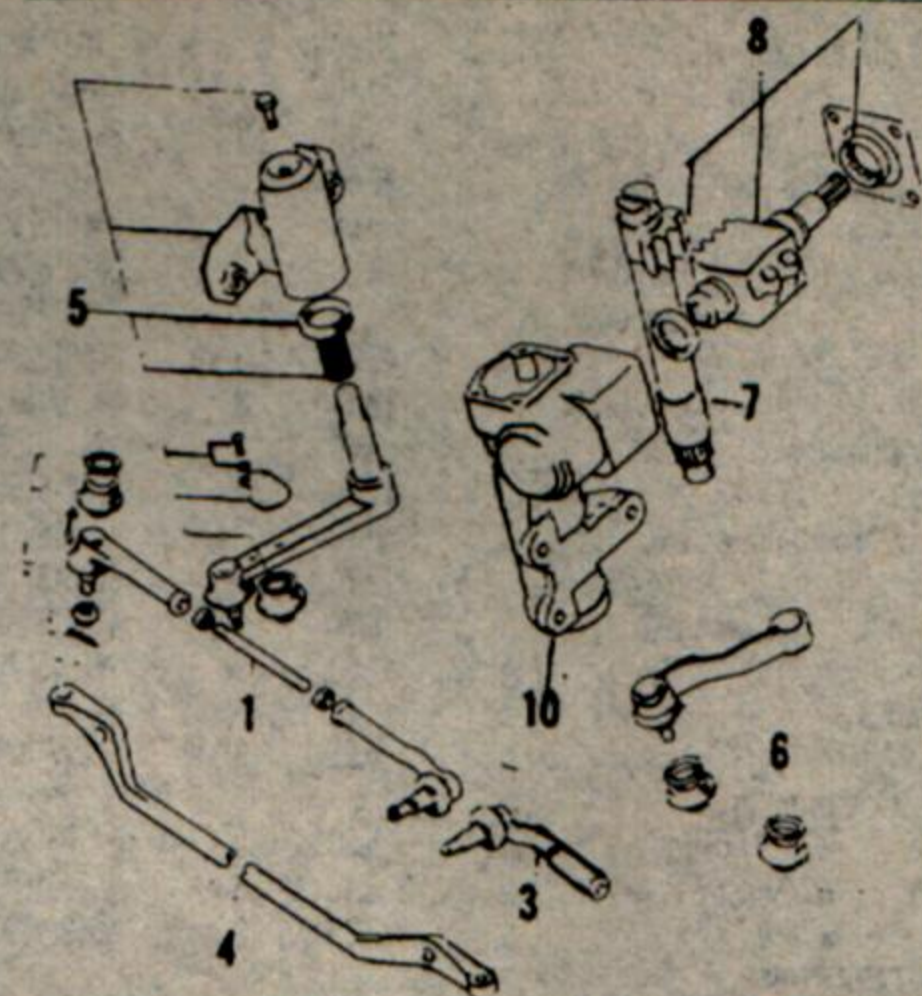

Arm, see steering knuckle			
1 Tie rod adjusting tube	6.60	#.7	030532365
2 end, otr, exc	17.95		086699324B
-fm 2/75	20.00		117599324A
-76-78	20.00		117599324A
3 -inr, exc	18.95		117799322A
-fm 2/75	20.00		117599322A
-76-78	20.00		117599322A
4 Drag link, exc	44.85	.8	170832261
-fm 2/75	44.85	.8	175732261A
5 idler arm assy, exc	58.65	.4	359732320
-76-78	58.65	.4	359732320
6 Pitman arm, exc	47.80	.4	117749320
-fm 2/75	35.85	.4	175732220A
7 Sector shaft, Std Strg	56.20	.9	101132141
-Pwr Strg	104.10	.9	352749140
8 Worm & ball-nut, Std	67.00	2.0	211332130
9 Gear assy, PS exc	549.35	1.1	352732110D
-76-78	549.35	1.1	359832110
10 housing, Std Strg	37.80	#1.5	170832120
-Pwr Strg	139.77	2.2	359849120
Valve & piston	488.42		359849180

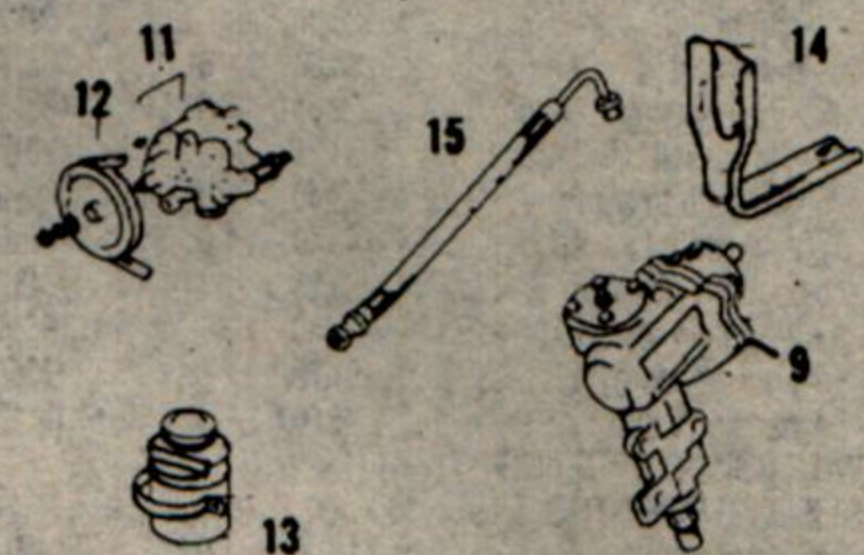

11 Power steering pump	312.45	\$.7	352732600D
12 pulley	20.30	.3	352732601
13 reservoir, exc	18.20	.3	352732740D
-fm 4/74	18.20	.3	352732740D
-76-78	18.20		352732740D
-mtg brkt	1.00		352732745
14 hose, pressure		.2	999995999
Main shaft & column—			
assy, Std Strg	89.70	.5	101132100A
-Pwr Strg	88.60	.5	352732100C
coupling	12.70		018732850C
Mounting plate, lower	7.25		852032410A
Wheel & horn button	148.00	.3	193432980B
pad, exc	8.50		179332800
-76-78	7.90		193432800

Time is for overhaul.
§ With air cond, add .1.

CONTINUED

COWL & WINDSHIELD

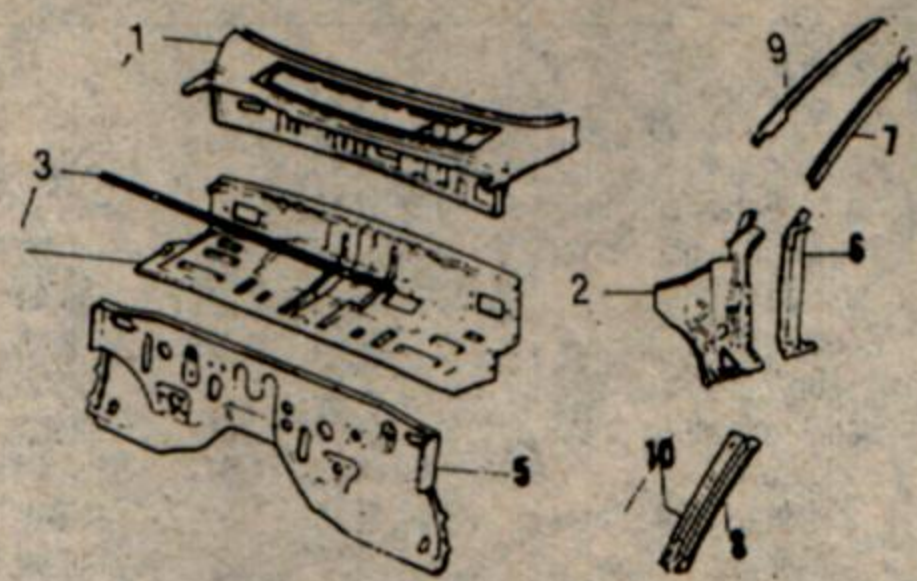

1	Cowl panel, upper, exc ... (p1.0)	44.10		170874040C
	-fm 7/74 ... (p1.0)	44.10		170874040C
2	side ... (p.6)	24.50	# 3.0	817370020A
3	weatherstrip ...	6.30		B00156791
	ventilator grille ...	17.60	.3	170850791A
4	Dash panel, upr, exc ...	101.00		GA0253510
	-fm 10/74 ...	82.55		39585310E
5	-lwr, exc ...	87.80		170853400G
	-76-77 ...	87.80		170853400G
	-78 ...	87.80		170853400G
6	Hinge pillar ... (p1.0)	27.90	§ 5.0	101170210-12100
	Windshield pillar—			
	outer—			
7	Sed & SW, 74-75 ...	14.60	† 2.0	100474090-1200
	-76-78 ...	15.50	† 2.0	364674090-1200
8	H'Top-74-75 ...	15.95	† 2.0	101174090-120
	-76-77 ...	15.50	† 2.0	364674090
9	inner, exc ...	9.20	† 1.0	100470241A-1241A
10	-Hardtop ...	9.47	† 1.0	101170241-1241
	glass, Mazda			
	H'Top ...	169.60	2.6	175463901C
	Sedan ...	169.60	2.6	174163901D
	Sta Wgn, exc ...	169.60	2.6	174163901D
	-75-78 ...	165.65	2.6	357169301A
	glass, NAGS—			
	Sed & StaWgn, clear ...	409.30	2.6	FCW296C
	-tinted ...	431.20	2.6	FCW296T
	H'Top, clear ...	403.70	2.6	FCW295C
	-tinted ...	425.35	2.6	FCW295T
	rubber channel ...	3.90		124363902
	mldg reveal—			
	upr, Sed & SW, exc ...	9.75		100499741A
	-78 ...	9.75		100499741A
	-H'top ...	9.75		101199741
	side, Sed & SW exc ...	6.60		100499743A
	-76-77 ...	6.60		100499743A-4A
	-78 ...	6.60		100499743A
	-H'top ...	6.60		101199743A-40
	lwr, 73-75, right ...	6.75		101199742
	-left ...	4.80		100499745
	-76-77 ...	6.75		101199742-50
	-78 ...	6.75		101199742A-5A
	-joint, lower ...	1.30		086670454
	Instrument cluster trim ...	83.90		170855410 05
	Crash pad, exc ...	117.85	> 2.2	170860350F00
	-76-78 ...	117.85	> 2.5	170860350F00
	Door, glove compartment ...	25.00	.5	101164030B00
	Wiper arm ...	11.95	.2	175767321A
	blade ...	5.35	.2	175767330A
	motor ...	107.55		175767350
	washer, reservoir ...	6.60		031767511
	-pump ...	21.00		030587933
	Mirror, rear view ...	18.80	.1	083969170
	Sun visor, R ...	10.00	.1	175769270A05
	-L ...	10.00	.1	175769320A05

After hinge pillar & glass are removed.
 § After fender, door and windshield are removed.
 † After windshield is removed.
 ‡ After outer pillar is removed.
 > With air cond, add 1.7.

ROOF & BACK WINDOW

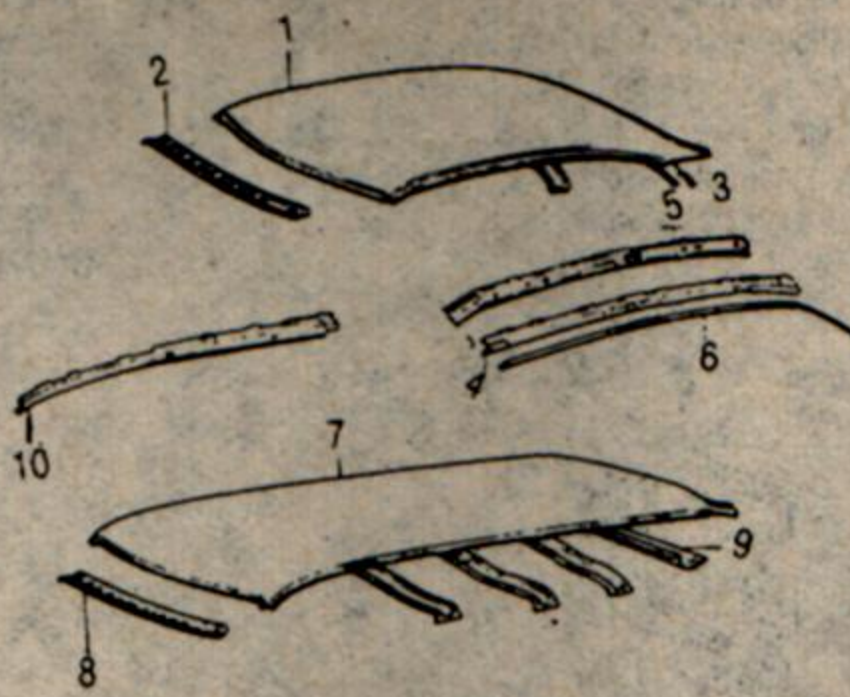

Headlining R&I, Sed & Coupe— 2.3, Sta. Wgn. 2.6				
SEDAN				
1	Roof panel ... (p3.2)	179.65	16.0	102974030
2	rail, above W/S, exc ...	16.95	# 1.5	100470640
	-76-78 ...	16.05	# 1.5	364870640
3	rear above back wndo ...	14.00	# 1.5	101170701A
4	side, outer ...	14.10	# 2.0	100470251-1251
5	-inner ...	9.09		100470050A-1050A
6	Rain gutter ...	7.59	# 2.0	100470311-1311
	chrome cover, front ...	6.50	.2	100499702-70
	-rear ...	6.90	.2	100499703-80
	-joint ...	1.20		100450443
Back window—				
	glass, heated ...	145.80	2.4	115763931E
	rubber channel ...	4.70		086670473
	mldg, reveal, upper ...	6.10		100499746
	-side ...	4.30		100499748-90
	-lower ...	8.55		100450690A
	-joint ...	2.40		100450920-60
STATION WAGON				
7	Roof panel ... (p3.7)	179.65	17.0	102974030
8	rail, above w'shield ...	16.95	# 1.5	100470640
9	rear above gate ...	11.05	# 2.0	B00170700A
10	side, outer ...	11.77	# 2.0	102970251-1251
	-inner ...	10.90		816770050B
	Rain gutter ...	7.10	# 2.0	102970311-1311
	chrome cover, front ...	6.50	.2	100499702-70
	-rear, r&l ...	8.00	.2	102999703A
	-joint ...	1.20		100450443

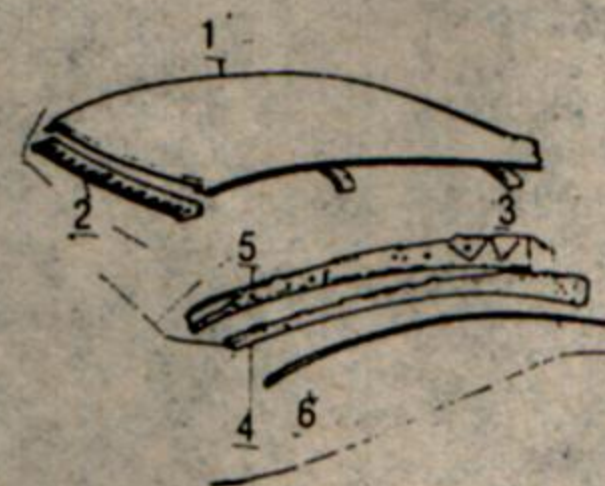

HARD TOP				
1	Roof panel, exc ... (p3.2)	110.60	16.0	101174030A
	-fm 11/73 ... (p3.2)	110.60	16.0	101174030A
	rail—			
2	above W/S, 74-75 ...	16.05	# 1.5	364870640
	-76-78 ...	16.05	# 1.5	364870640
3	above bk wndo, exc ...	14.00	# 2.0	101170701A
	-fm 2-74 ...	14.00	# 2.0	101170701A
4	side, outer ...	27.90	# 2.0	817370250B
5	-inner ...	16.30		101170050-10500
6	Rain gutter ...	10.50	# 2.0	817370311A
	chrome cover ...	15.15	.2	101199702A-70
	W'strip, over dr & qtr ...	19.25	.6	175758771
	retainer ...	45.80		817358780B
Back window—				
	glass, heated ...	150.30	2.4	115763931C
	rubber channel ...	3.90		124363902
	mldg, reveal, upper ...	6.10		101199746
	-side ...	4.80		101199748-90
	-lower ...	11.80		101150690A
	-joint ...	2.20		101150515-60

After roof panel is removed.

FRONT DOOR

SEDAN & STATION WAGON				
	Assembly, Remove & Reinstall3	
	Trim panel, Remove & Reinstall3	
	Door, exc ... (p2.5)	260.00	3.5	175558010C-9010D
	SW fm 4/74 ... (p2.5)	268.00	3.5	179158010C-9010C
	Outer panel, exc ... (p2.5)	51.20	# 4.5	175558020B-9020B
	-fm 11/73 ... (p2.5)	51.20	# 4.5	175558020B
	Weatherstrip around door ...	17.60	.6	100458760-97600
	Moulding, belt at wndo ...	26.75	.3	100499732C-7A
	window frame, front ...	7.95		100450521-50
	-rear ...	5.10		086659842A
	Mirror, rear view ...	26.15	.2	285069090
	Glass ...	43.00	.7	100458501F-9501E
	sash channel ...	6.60		100458505-95050
	guide channel, front ...	3.65		100458603-9603
	-rear ...	2.80		100458604-96040
	regulator ...	25.90	.5	100458560-95600
	Handle, outside ...	32.80	.3	172758420A-9420A
	Lock ...	39.80	.4	100458310D-9310D
	striker ...	3.35	.1	086658361C-9361C
	cylinder & keys ...	16.00	.3	083974920A
	Hinge, upper ...	15.75	§ 3	101158210
	-lower ...	23.90	§ 3	086658240D-9240D
HARDTOP				
SEE SEDAN & STA WGN, EXC				
	Door ... (p2.5)	290.55	3.5	175758010A-9010A
	Outer panel ... (p2.5)	62.80	# 4.5	175758020-90200
	Weatherstrip around door ...	26.00	.6	101158760A-9760A
	Moulding, belt at wndo ...	26.40	.3	101199732-70
	Glass ...	93.75	.7	101158500E
	guide channel, front ...	8.50		101158602
	-rear ...	8.50		101158602-96020
	regulator ...	27.80	.5	10115860C-9560C
	Lock ...	39.80	.4	101158310E-9310E
	striker ...	3.35	.1	086658361C-9361C
	Hinge, lower, exc ...	23.90	§ 3	101158240C-9240B
	-fm 10/74 ...	23.90	§ 3	101158240C-9240C

Time is for cutting at belt.
 § Time is for one, both .5.

CENTER PILLAR

	Pillar, outer, exc ... (p1.0)	37.60	# 5.0	102970350-13500
	-SW fm 4/74 ... (p1.0)	37.60	# 5.0	102970350-13500
	inner ...	12.65		100470090D-1090D
	Moulding ...	9.00		100499704A-9A

With rocker panel removed or cut below roof panel 4.0.

REAR DOOR

	Assembly, Remove & Reinstall3	
	Trim panel, Remove & Reinstall3	
	Door, Sedan, exc ... (p2.5)	237.20	3.5	175572010A
	-fm 10/74 ... (p2.5)	237.20	3.5	175572010A-3010A
	-Sta Wgn, exc ... (p2.5)	237.20	3.5	175572010A
	-fm 10/74 ... (p2.5)	237.20	3.5	175572010A
	-76-78 ... (p2.5)	237.20	3.5	175572010A
	Outer panel, R ... (p2.5)	41.90	# 4.5	100472020A
	-L ... (p2.5)	41.90	# 4.5	100473020A
	W'strip around dr, Sed ...	13.75	.6	100472760-37600
	-SW ...	19.25	.6	102972760-37600
	Moulding, belt at wndo ...	18.80	.3	100499733C
	extn rear, Sedan, R ...	12.25		870251920A
	-L ...	12.25		100451970
	-Sta Wgn ...	7.50		102951930-800
	window frame, front ...	5.10		086658842A
	-upper, exc ...	5.40		100450531-50
	-Sta Wgn ...	4.55		102950535A
	-rear, Sta Wgn ...	5.30		102950532-60
	Glass, Sedan ...	29.70	.7	100472501D-3501B
	-Sta Wgn ...	29.70	.7	102972501C-3501B
	sash channel ...	4.35		100472505
	regulator ...	17.90	.5	100472560-35600
	Vent glass, Sedan ...	8.35	.5	100472661D
	-Sta Wgn ...	9.40	.5	102972661C-3661C
	rubber channel, Sedan ...	4.50		100472651
	-Sta Wgn ...	7.80		102972651
	division channel, Sedan ...	6.75		100472602-36020

CONTINUED

1978-73 MAZDA RX4

REAR DOOR (CONT)

-Sta Wgn	7.50		101172602
Handle, outside, exc	20.70	.3	172572410-34100
-fm 11/74	27.35	.3	172572410A-3410A
Lock, exc	38.60	.4	853272310B
-76-78	36.80	.4	100472310D-3310D
striker	3.35	.1	086658961C-9361C
Hinge, upper	9.20	\$.3	100472210-32100
-lower, exc	23.95	\$.3	086672240C
-fm 10/74	23.95	\$.3	086672240C-3240C

Time is for cutting at belt.
\$ Time is for one, both .5.

ROCKER PANEL

SEDAN & STATION WAGON

Panel, outer	(p1.0)	44.10	#7.0	069770270-12700
-inner		34.85	†2.5	101153950D
Moulding, R-L		17.95	.3	179399720
extn, front on fender		6.75	.2	179399721-60
-rear on qtr, exc		18.00	.2	179399765A
-76-78		3.40	.2	851999723-80
Sill plate, front		17.25	.2	100468711B-21B
-rear		6.00	.2	100468716A-26A

HARD TOP

Panel, outer	(p1.0)	79.35	\$.5.0	101170270-12700
-inner		34.85	†2.5	101153950D
Moulding, R-L		17.95	.3	179399720
extn, front on fender		6.75	.2	179399721-60
-rear on quarter		19.20	.2	179399760A-5A
Sill plate		17.25	.2	100468711B
extn, rear		5.85		101168716B-26B

Cut & splice in either door opng 3.5. With hinge or lock pillar removed 5.5. With center pillar removed 5.5.
\$ Cut in door opening 3.5.
† After outer panel is removed.

SEAT TRACKS

Track, R-L, outer, exc	15.20	#4	101188102-530
-H'Top, R	23.00	#4	173788102
-L	17.80	#4	100988153A
-inner	8.30	#4	101188103-520

Time is for overhaul.

REAR QUARTER & LAMPS

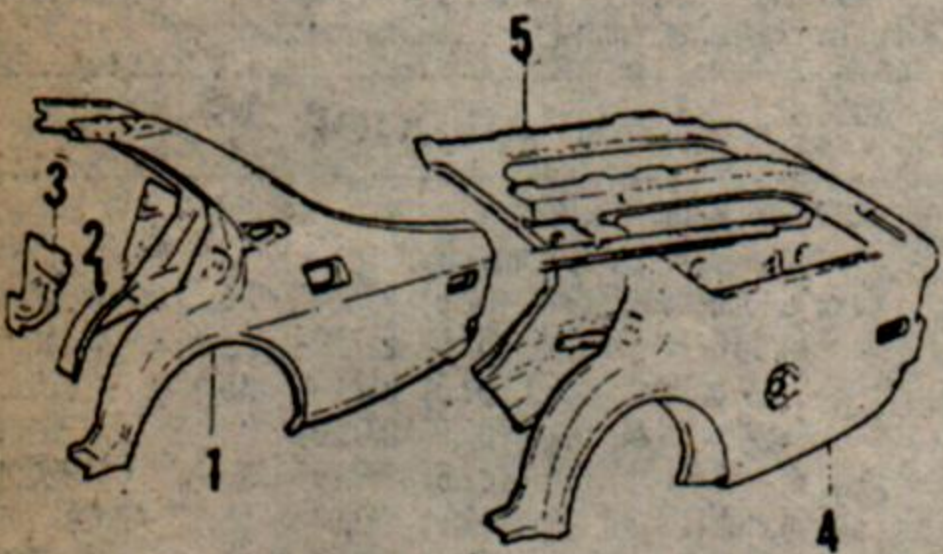

REAR QUARTER, SEDAN

Outer panel—				
1 left	(p2.5)	176.90	9.5	100474130E
right	(p2.5)	176.90	9.0	100474100E
Inner panel—				
2 left		83.95	#4.5	100471100E
right		83.95	#4.5	100470100F
3 Flr plate, lwr at lock plr		3.05		100470404-1404
Door, gas filler		8.50	.3	101142410A
Air flow grille		12.55		100451901A-51A
duct		4.39		100451911A-61A
Name, Mazda	(d.1)	9.85	.2	172751721
-RX4	(d.1)	8.50	.2	172751761
-Rotary Engine	(d.2)	4.20	.2	173051775

STATION WAGON

4 Outer pnl, L, exc	(p2.8)	254.10	12.5	178970400C
-76-78	(p2.8)	254.10	12.5	178971400C
-R, exc	(p2.8)	254.10	11.5	178970400C
-76-78	(p2.8)	254.10	10.0	178970400C
5 Inner panel, left exc		151.70	#5.0	102971100B
-fm 5/74		151.70	#5.0	102971100B

-R	91.90	#5.0	102970100A
6 Flr plate, lwr at lock plr	3.05		100470404-1404
Door, gas filler	9.65	.3	102971510C
Air flow grille	49.95	.3	102951901C-51C
Mldg, vert on plr upr, exc	14.30		102950580C
-fm 5/74	14.30		102950580C
Glass	36.80	.8	102963951C
inner pnl, L exc	30.95		102963952B
mldg, belt at wndo, exc	17.80		102999733A-8A
-76-78	17.80		102999733B-8B

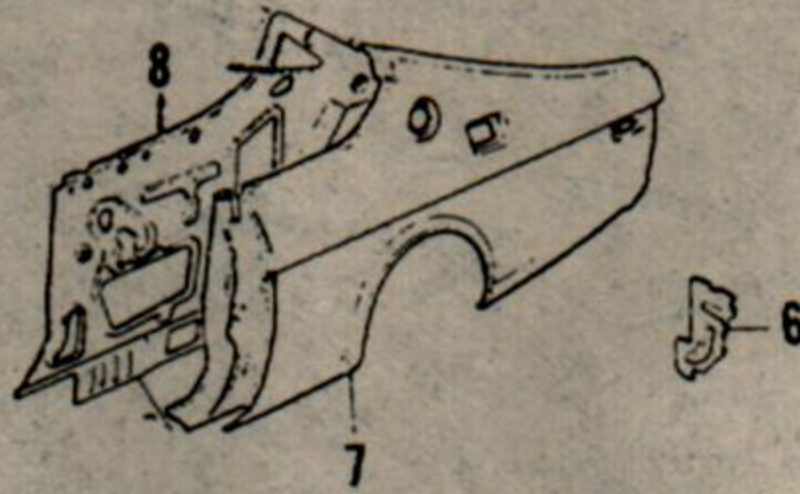

HARD TOP

Outer panel—				
7 left, exc	(p2.0)	254.10	11.5	364874130D
-fm 11/73	(p2.0)	254.10	11.5	364874130D
-76-78	(p2.0)	254.10	11.5	364874130D
right, exc	(p2.0)	254.10	11.0	364874100D
-fm 11/73	(p2.0)	254.10	11.0	364874100D
-76-78	(p2.0)	254.10	11.0	364874100D
Inner panel—				
8 left, exc		112.40	#5.0	101171100A
-75-78		139.20	#5.0	101171100H
right, exc		80.10	#5.0	101170100G
-76-78		80.10	#5.0	101170100G
-76-77		80.10	#5.0	101170100G
Door, gas filler		8.50	.3	101142410A
Air flow grille, exc		7.40	.3	179351911
-76-78		12.70	.3	364851911
duct		5.25		101151921-510
Name Mazda	(d.1)	9.85	.2	172751721
RX4 (d.1)		8.50	.2	172751761
Rotary Engine exc	(d.2)	4.20	.2	179351775
-76-78	(d.2)	4.55	.2	374369085
Moulding, belt at wndo		29.30	.2	101199733A
Glass, w/lift brkt & w/strip—				
assembly		68.75	1.1	101172510I-3510H
regulator		33.00	1.1	030572560
guide, front		23.50		101172610B-3610B
-rear		7.50		101172602-36020

SIDE MARKER LAMP

Assembly, exc	17.40	.2	175589673-80
-Hardtop	17.40	.2	175789673-80
Lens & hsg, exc	10.90	.1	175551551-610
-Hardtop	10.90	.1	175751551-610
Bulb	.65		0000110089

FLASHER LAMP, REAR, STA WGN

Assembly	42.50	.2	179189674-90
Door	10.50	.2	102951183-930
Lens	11.20	.2	179151181A-91A
Base, & gasket	6.30		102951184A-94A
Bulb	.90		0000111156

After quarter panel is removed.

TRUNK LID

Assy, Remove & Reinstall		.4		
Trunk lid, Sed exc	(p2.0)	109.65	1.0	100452610A
-76-78	(p2.0)	127.60	1.0	364852610
HardTop, exc	(p2.0)	78.10	1.0	101152610
-76-78	(p2.0)	127.60	1.0	364852610
Name, Mazda		4.35	.1	870251781A
-Rotary Engine		4.55	.1	374369085
Lock		8.50	.2	101156820A
striker		1.70	.1	101156880
cylinder & keys		12.90		043775930A
Torsion spring, Sedan		3.65		100452761A-71A
-H'Top		3.90		101152761-710
protector		.95		101156805
Hinge, Sedan		4.00	#2	100452710A-200
-H'Top		5.60	#2	101152710A-200
W'strip in gutter, Sed exc		19.60	.5	100456991A
-76-78		19.60		100456991A

-H'Top	18.40	.5	101156991A
--------	-------	----	------------

After lid is removed.

LIFT GATE & LAMPS

LIFT GATE

Gate	346.30	#2.5	069862010C
Trim panel, inner	49.10	.2	069868960
Name, Rotary Wagon	4.50	.2	102951789
Trim plate & moulding	51.85	.3	102950850
moulding only	13.45		102999727
Glass heated	140.60	1.1	102963931E
rubber channel	30.95		102963932A
Handle, outside	57.00	.3	102950890A
Lock, exc	26.15	.3	102962310A
-from 8/74	26.15	.3	102962310A
striker	7.65	.2	102962361
remote control	8.20		102962320
cylinder & keys	12.90		069875960
Dovetail, lower, R-L	1.20		062162650
wedge	3.90		062162640A
Wedge, side, R-L	2.10		102962821
Torsion arm	11.62		102962290B-3290B
Hinge	29.20	\$.1.2	102962210B-3210B
cover, side	4.00		102968081-91
-center	31.75		102968061A
W'strip around gate	23.90	.6	102962761A

TAIL & BACK-UP LAMP, STA WGN

Assembly	60.85	.3	179189664-90
Door	23.50	.3	102951163-730
Lens	22.25	.3	102951161A-71A
Base & gasket	8.65		102951164-74
Bulb, exc	.90		0000111156
-back-up	.50		0000111157

LICENSE LAMP, STATION WAGON

Assembly, each	10.70	.1	102989665
Lens	2.35	.1	102951273
Bulb	.65		0000110089

With heated glass 3.0.

\$ Time is for all.

REAR BODY & LAMPS

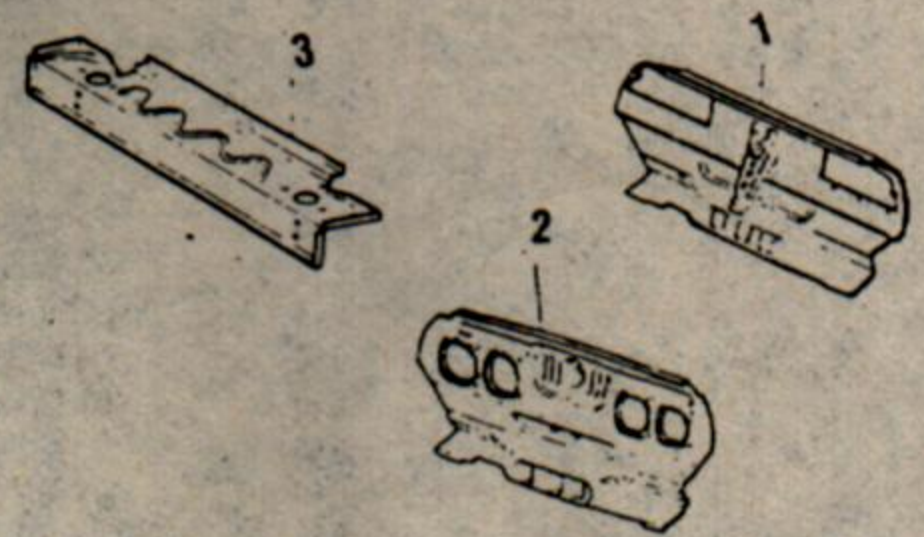

REAR BODY, SEDAN

1974-75—				
1 pnl below lid exc	(p1.0)	41.25	#6.5	175570750A
-fm 3/74	(p1.0)	41.25	#6.5	175570750C
-76-78	(p1.0)	67.35	#6.5	364670750
trim panel—				
assy w/mldgs		45.80	†5	100450850A
mldg upper		5.70	†	100450845
-lower		7.95	†	100450846
1976-78—				
panel below lid	(p1.0)	67.35	#6.5	364670750
trim panel—				
assy w/mldgs & ref		117.60	†5	364650850 52
mldg, upper		11.45	†	364650852
-lower		9.50	†	364650855A
-corner upper		7.75	†	364650853-40
reflector		3.90		041951571A
Sidemember		72.05	@7.5	111453810C

REAR BODY, HARDTOP

1974-75—				
2 panel below lid	(p1.0)	41.25	#6.5	175770750
trim panel—				
assy w/mldgs		117.60	†5	101150850C
emblem		9.35		101189611

CONTINUED

REAR BODY & LAMPS (CONT)

name plate, Mazda	8.30	.2	101151781
reflector	4.30	.2	175751580
1976-78—			
panel below lid (p1.0)	67.35	#6.5	364670750
trim panel w/mldgs & t'lamp			
door—			
assembly	136.00	†.5	364850850A52
t/lamp door see electrical			
mldg, upper	9.95	‡	364850853
-lower	9.50	‡	364850856
-side	8.20	‡	364850854A-50A
Sidemember	72.05	@7.5	111453810C
REAR BODY, STATION WAGON			
3 Pnl, below gate, exc (p.8)	11.00	\$3.5	102970751D
-75-78 (p.8)	11.00	\$3.5	102970751D
Reflector	6.00	.2	102951580
Floor pan, rear, exc	488.42		102953700A
-75	585.08		102953700B
-76-78	666.80		102953700E
Crossmember, exc	29.15	>2.5	102953880B
-76-78	18.60	>2.5	853153940A
Sidemember	85.89	@7.5	102953810A-4810D
TAIL LAMP, SEDAN			
1973-75			
Assembly	102.90	.3	175589664-90
Door	37.80		100451151A-61A
gasket	7.50		100451155-650
Lens, inner	8.00	.3	100451158A-68A
-outer	8.00		100451159A-69A
Bulb, each	.50		0000111157
TAIL LAMP, SEDAN			
1976-78			
Assembly	60.85	.4	364651150-600
gasket	7.50		100451155-650
Lens, outer	8.00	.4	100451158A-68A
-inner	8.00		100451159A-69A
Socket & wire	5.10		172551153
Bulb, turn signal	.50		0000111157
-stop & tail	.90		0000111156
TAIL LAMP, HARDTOP			
Assy, each (4-used)	33.85	.3	175789664
Lens & body	17.30	.3	101151151
gasket	2.70		101151152
Bulb, exc	.50		0000111157
-flasher	.90		0000111156
TAIL LAMP, HARDTOP			
1976-78			
Assembly	57.90	.4	364851150-600
Lens, outer	10.40	.4	364851151-610
-inner	16.50		364851152A-62A
gasket	2.50		364851154
Door	3.65		364850852
Bulb, turn signal	.50		0000111157
-stop & tail	.90		0000111156
holder	8.30		101151174A
BACK-UP LAMP, SEDAN			
Assembly	17.60	.2	175589654
Bulb	.90		0000111003
BACK-UP LAMP, HARDTOP TO 10/74			
Assembly	21.90	.2	243589654
Door	6.90		243566338
gasket	1.70		243566337
Lens	3.50	.1	243566335
Bulb	.90		0000111003
BACK-UP LAMP, HARDTOP FROM 11/74			
Assembly	21.90	.2	356589654-90
Lens, back-up	5.60	.1	356551244-540
-reflector	8.10	.1	356551242
gasket, back-up	2.15		356551246
Bulb	.90		0000111003

With bumper & lamps removed with one quarter removed 5.0. Both 3.5.
 § With bumper removed
 † Time includes all mouldings
 ‡ Use finish panel time
 > After rear body panel is removed.
 @ After all bolted-on parts are removed. With wheelhouse removed 3.0.

FUEL

SEDAN & HARDTOP, TO 9/74			
Gasoline tank	87.50	.9	101142110
filler, pipe	11.10		101142210
-cap	3.40		817342250
-door, see qtr			

expansion tank	29.00		101142320C
SEDAN & HARDTOP, FROM 10/74			
Gasoline tank, exc	128.65	.9	356542110B
-76-78	128.65	.9	356542110B
filler, pipe, exc	25.45	.3	355842210
-lead gas		.3	357642210
-cap	3.40		817342250
-door, see qtr			
expansion tank, exc	29.00		101142320C
-76-78	29.00		101142320C
STATION WAGON, TO 9/74			
Gasoline tank	132.30	1.6	102974110
filler, neck, to 2/74	13.15	.4	102942210C
-fm 2/74	13.15	.4	102942210C
-hose, exc	19.00		102942240
-fm 5/74	21.00		102942240B
-cap	3.40		817342250
-door, see qtr			
expansion tank, exc	29.00		102942321B
-76-78	29.00		102942321B
STATION WAGON, FROM 10/74			
Gasoline tank	132.30	1.6	102974110
Filler pipe—			
unleaded gas, exc	24.50		362942350C
-76-78	24.50		362942350C
lead gas	13.15	.4	102942210C
hose	21.00		102942240B
cap	3.40		817342250
door, see quarter			
expansion tank, exc	29.00		102942321B
-76-78	29.00		102942321B
ALL MODELS			
cover, Sed & H'top	16.00		101156320F
-Sta Wgn	15.75		102956311B
filter	2.50		022213470B
Carburetor, exc	373.70	.9	175713200A
std trans, 75	373.35	.9	352513200A
-76-78	465.60	.9	364813200
auto trans, 75	393.00	.9	362513200A
-76-78	465.60	.9	364913200
Intake manifold, exc	56.20	1.8	175713100A
-75	73.80	1.8	356513100A
-76-78	78.70	1.8	364813100F
gasket, 75	.85		175713111A
-76-78	.95		364813111A
Air cleaner, exc	119.50	.2	356513300
-75	119.50	.2	356513300
-76-78	131.40	.2	364813300B
Vapor check valve, exc	11.00		269142710A
-fm 2/74	16.30		852742910
-76-78	24.95		364842910
Starting fluid tank, exc	37.90	.2	175713510B
-75-78	37.90	.2	175713510B

REAR SUSPENSION

Brake drum	32.70	.4	101126251A
support plate	15.23	1.1	101126280-90
pipe, exc	11.29	.6	111443660A
-Sta Wgn	13.48	.6	179143660B
-76-78	11.85	.6	179143660C
Axle shaft	86.60	1.0	102926111A
Bearing, rear wheel—			
brg, w/seal & col, exc	18.25	1.0	101199265
-SW	25.10	1.0	069899265
-oil seal	1.50		101126154
-collar	7.10		101126152
-gasket	.70		101126129A
HSG SED & HT exc	237.15	3.5	107826010C
-75-78	237.15	3.5	107826020A
-Sta Wgn, exc	233.80	3.5	179126010C
-76-78	237.15	3.5	365026020
Spring, Sed & H, Top	85.70	.9	175728010A
Sta Wgn, exc	137.85	.9	365028010
-75-78	137.85	.9	365028010
main leaf, Sed & H'Top	31.90	1.1	175728011
Sta Wgn, exc	38.30	1.1	102928011
-76-78		1.1	365028011
Torque rod, Sed & H'top	60.55		175799283
Shock absorber, exc	25.80	.4	896199281
Sta Wgn, 75-78	25.80	.4	896199281

REAR BUMPER & LAMPS

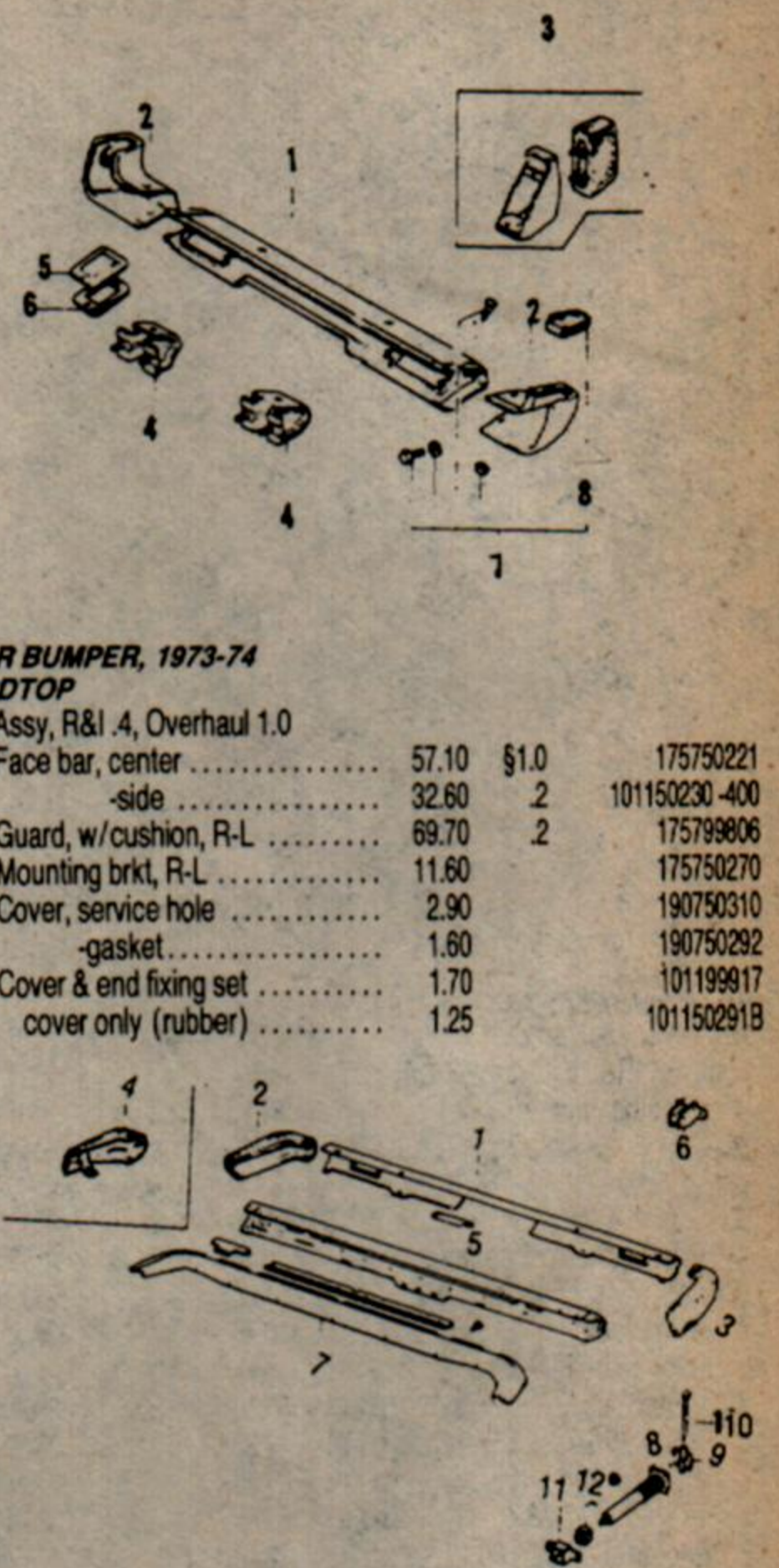

REAR BUMPER, 1973-74 HARDTOP

Assy, R&I .4, Overhaul 1.0			
1 Face bar, center	57.10	\$1.0	175750221
2 -side	32.60	.2	101150230-400
3 Guard, w/cushion, R-L	69.70	.2	175799806
4 Mounting brkt, R-L	11.60		175750270
5 Cover, service hole	2.90		190750310
6 -gasket	1.60		190750292
7 Cover & end fixing set	1.70		101199917
8 cover only (rubber)	1.25		101150291B

REAR BUMPER, 1973-74 SEDAN & STA WGN

Assy, R&I .5, Overhaul 1.2			
Face bar—			
1 center, Sedan	34.95	\$1.2	175550221B
-Sta Wgn	34.95	\$1.2	179150221A
2 side, Sed, R, exc	22.10	.2	175550250A
-from 3/74	22.10	.2	175650250
3 -L	36.05	.2	175650260
4 -SW, exc	28.90	.3	179150250C-60C
-fm 2/74	28.90	.3	179150250C-60C
5 Reinf, Sedan exc	64.10		175550230B
-from 3/74	104.65		175550230D
-Sta Wgn	64.10		179150230B
6 mtg brkt, Sedan	10.25		175552810-400
-Sta Wgn	10.25		179152810
7 Filler to body, Sed exc (p1.0)	53.15		175550350A00
-fm			
3/74 (p1.0)	49.95		175650350B00
-SW exc (p1.0)	49.95		179150350A00
-from			
3/74 (p1.0)	49.95		179150350A00
8 Energy absorber, exc	22.45	#.2	175550100B
-from 3/74	22.45	#.2	175550100B
-Sed, from 6/74	23.85	#.2	175650100A
9 hinge plate, to face bar	6.55		175550080A
-bolt	1.50		175550271A
10 bracket, exc	4.35		175550301
-Sed, from 3-74	14.20		175650300
12 rubber mtg, rear exc	1.80		175550091
-Sed from 6/74	1.80		175650091
Valance pnl, Sed, exc (p.6)	27.90	.6	175552860C
-from 3/74 (p.6)	27.90	.6	175552860C

CONTINUED

1978-73 MAZDA RX4

REAR BUMPER & LAMPS (CONT)

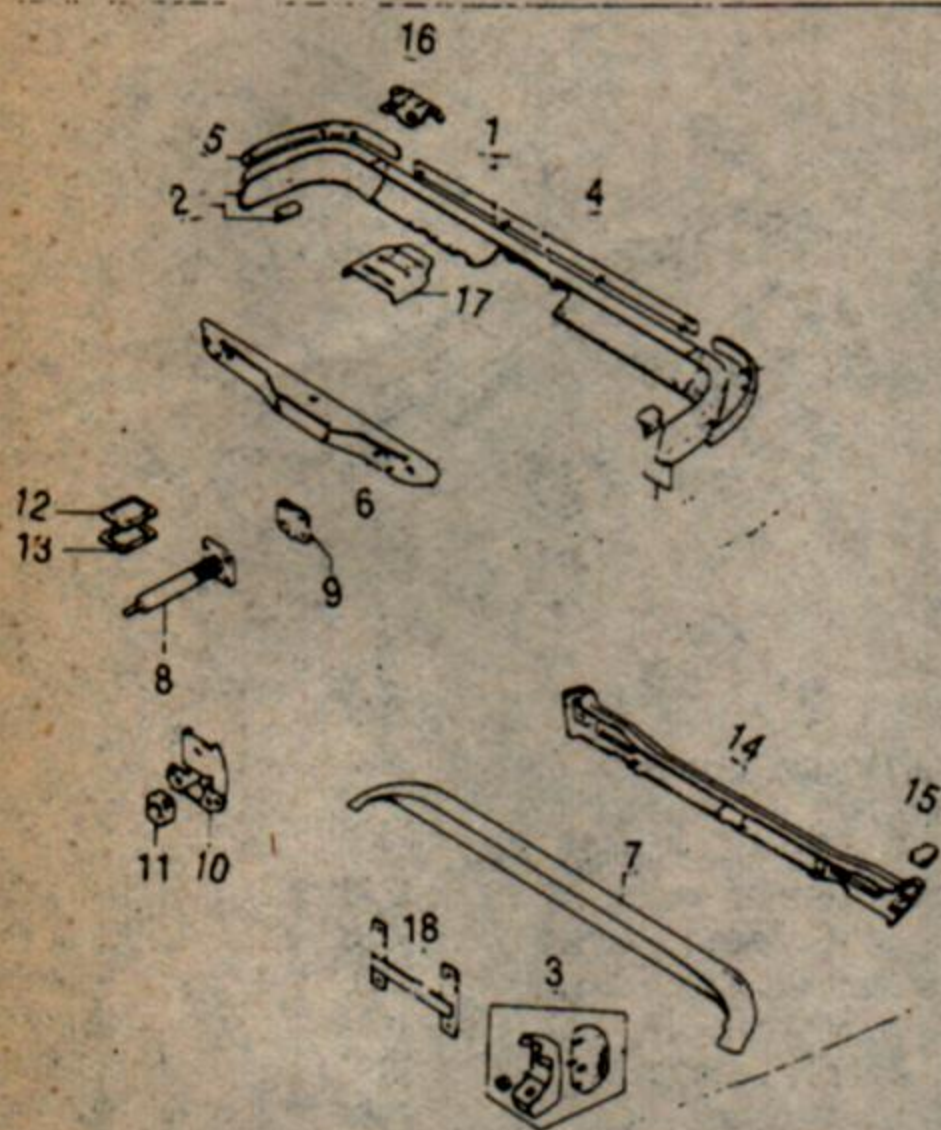

REAR BUMPER, 1975-78 SEDAN & HARDTOP

Assy, R&I .5, Overhaul 1.3			
1	Face bar, center	99.95	\$1.3 356550221A
2	-side, 75	29.10	.4 356550930-400
	-76-78	29.10	.4 362950222-30
3	Guard, w/cushion, R-L	59.40	.2 356599806A
4	Rubber cushion, center	12.70	.5 356550380E
5	-side, R-L	7.65	356550390E
6	Reinforcement	110.45	356550230B
Filler, to body—			
7	Sed, exc	(p1.0) 50.80	356150350B
	-76-78	(p1.0) 49.80	364651840A
	H'Top, exc	(p1.0) 66.85	356550350B
	-76-78	(p1.0) 53.85	364851840A
8	Energy absorber, 75	62.40	#.3 356550100
	-76-78	69.50	#.3 364850290A
9	hinge plate, to face bar	7.85	356550080A
10	mtg brkt, to frame, R-L	15.45	364850300A
11	rubber mount	1.80	175650091
12	Cover, service hole	2.90	190750310
13	-gasket	1.60	190750292
14	Valance panel	(p.6) 27.90	.6 175552860C
15	cover, end (rubber), Sedan	1.90	175552951
	-H'top	1.86	356552951A-56A
16	Deflector, lower	4.35	356550363A
17	-upper	10.30	356550360A
18	License mtg plate	3.60	356550340

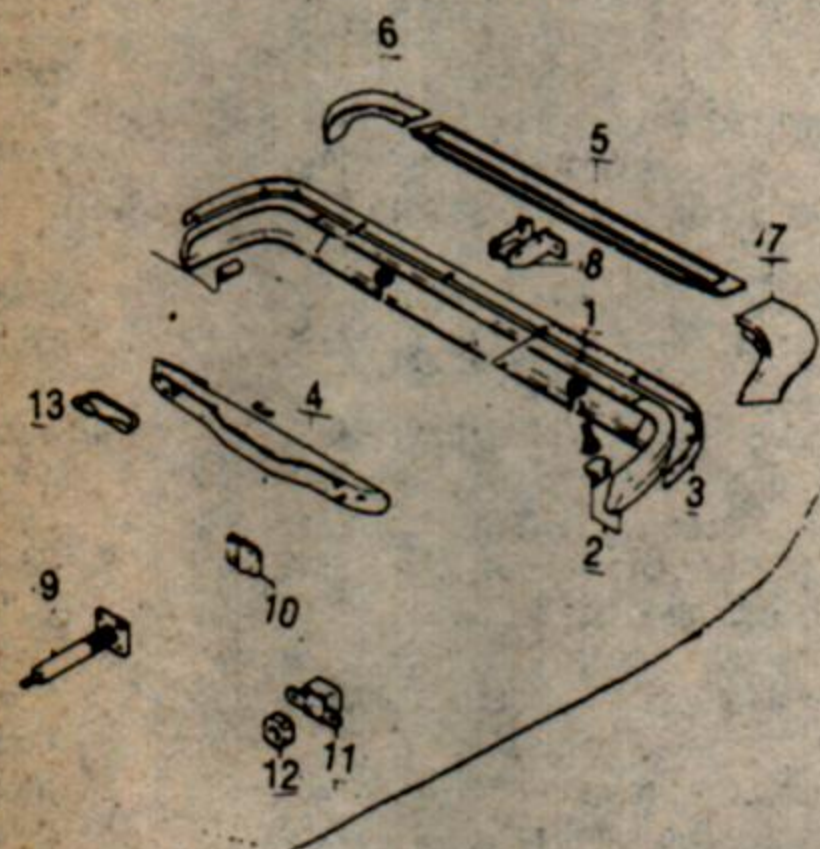

REAR BUMPER, 1975-78 STATION WAGON

Assy, R&I .5, Overhaul 1.0			
1	Face bar, center	99.95	\$1.0 357150221B
2	-side exc	29.10	.3 357150930-400
	-78	29.10	.3 357150930A-40A

3	Rubber cushion	27.90	357150380C
4	Reinforcement	86.20	357150230C
5	Filler, to body, center (p.8)	19.65	.5 357150351A
6	-side, R-L (p.3)	54.80	.3 357150370
7	Bracket, R-L	10.25	179152810
8	Energy absorber	62.40	#.3 357150100B
9	hinge plate, to face bar	7.85	356550080A
10	mtg brkt, to frame	13.75	362950110A
11	rubber mount	1.80	175650091
12	Deflector, right	4.35	356550363A
LICENSE LAMP, SEDAN & HARDTOP			
	Assembly, w/mtg brkt	7.10	.2 101189665
	-wo/mtg brkt	7.10	.2 175589665
	Lens	2.40	086666372
	Bulb	.76	997012070

After bumper is removed.
§ Time is for overhaul.